

## Low Optical Loss Wafer Bonded GaAs Structures for Quasi-Phase-Matched Second Harmonic Generation

YewChung Sermon Wu, Robert S. Feigelson, Roger K. Route,  
Dong Zheng, Leslie A. Gordon, Martin M. Fejer, Robert L. Byer  
Center for Nonlinear Optical Materials, Stanford University, CA94305,  
sermon@crystal.stanford.edu

### ABSTRACT

A periodic GaAs wafer-bonded structure has been proposed for quasi-phase-matched (QPM) second harmonic generation (SHG). However, current bonding processes often lead to unacceptable optical losses and poor device performance. In this study, three sources of optical losses in wafer-bonded structures were investigated, (1) interfacial defects between the wafers, (2) bulk defects within the wafers, and (3) decomposition at the exposed outer surfaces. Surface losses due to incongruent evaporation were easily eliminated by repolishing the outer surfaces. However, to minimize the losses from interfacial and bulk defects, it was necessary to investigate the relationship between these defects and the bonding parameters. It was found that an increase in bonding temperature and/or time led to a decrease in interfacial defects, but an increase in bulk and surface defects. Through a trade-off process, optimized processing conditions were developed which permitted the preparation of bonded stacks containing over 50 (100)-oriented GaAs wafers, and about 40 layers of (110)-oriented GaAs wafers. Optical losses as low as 0.1-0.3% /interface (at 5.3  $\mu\text{m}$  and 10.6  $\mu\text{m}$ ) were achieved.

### INTRODUCTION

GaAs has a large nonlinear coefficient, and a high optical damage threshold. However, its use in nonlinear optical applications has been limited because GaAs cannot be birefringently phase-matched. To overcome this problem, a periodic GaAs (110) structure prepared by a high temperature wafer bonding process has been proposed for quasi-phase-matched (QPM) second harmonic generation (SHG)[1]. However, current bonding methodologies often lead to the introduction of defects which adversely affect optical transmission.

Three kinds of defects have been found in bonded GaAs wafers: (1) interfacial defects between wafers, (2) bulk defects within individual wafers and (3) surface defects at the exposed outer surfaces. Interfacial defects included voids and inclusions. Bulk and surface defects included antisite defects, dislocations, impurities, vacancies, interstitials, and precipitates.

### EXPERIMENT

Three inch undoped semi-insulating GaAs wafers, either (100) or (110)-oriented, were used in this study. They were diced into 9 x 9 mm<sup>2</sup> dimensions, then solvent-cleaned in a class 100 clean room. Under a flowing gas mixture of H<sub>2</sub>(60 cc/min.) and N<sub>2</sub>(1l/min.), GaAs was bonded at 200 ~ 975°C for 0.5 ~ 19 hr with a compressive load ranging from 0 to 30 Kg. Finally, the effects of processing on bulk and surface defects, and the shrinkage of interfacial voids were analyzed using standard characterization techniques.

### RESULTS

Individual GaAs wafers were used to study how the bonding process affected bulk and surface defects. Figure 1 shows the transmittance of single GaAs wafers heat-treated for 2 hr. at

Fig. 1. Transmittance of single GaAs (100) wafers processed under a static 10 kg/cm<sup>2</sup> load for two hours at different temperatures ranging from 350 °C to 950 °C.

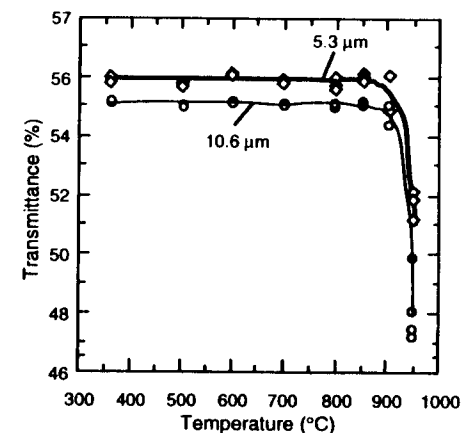

temperatures between 350°C and 950°C. When compared with unprocessed GaAs, the optical losses at the two wavelengths of interest for SHG were seen to increase when processing temperature exceeded 850 °C. The electrical properties also changed when the processing temperatures exceeded 850°C: the undoped semi-insulating wafers converted to *p*-type and their sheet resistance decreased at progressively higher temperatures. Most of the *p*-type conversion was on the surfaces (caused by arsenic depletion resulting from incongruent evaporation) and could be eliminated by repolishing.

In our interfacial defect study, artificial twin boundaries were created between GaAs wafer pairs as this is the configuration required for quasi-phase-matching. The investigation of interface void shrinkage followed the approach described in Refs. [2] in which artificial voids of various depths were created by bonding topographically-patterned wafers to unpatterned wafers in order to model the effect of random surface irregularities. Figure 2 shows IR transmission optical micrographs for two GaAs wafers containing 700 Å deep artificial voids that were bonded at 870 °C and 910 °C for 2 hr. The light features seen in the void area of Fig. 2(b) correspond to bonded areas which occurred through the nucleation and growth of islands by a mass transport process within the void space. The nature of the bonding in these regions was verified using high resolution transmission electron microscopy (HRTEM), as shown in Fig. 3. No other phases were found at the bonded interfaces, and only a few atomic layers were disrupted.

The "bonded fraction," as determined by estimating the light vs. dark areas on the IR transmission micrographs, was found to increase with temperature, consistent with the fact that mass transport increases with temperature[3]. We found that the detectable bonded fraction was a strong function of void depth. Bonding (or recrystallization) was not detected in 700 Å deep voids until the process temperatures reached 910 °C, as shown in Fig. 2. However, bonding was detected in 100 Å deep voids at process temperatures around 850 °C. These experiments showed that the bonded fraction in wafer-bonded GaAs depends strongly on the magnitude of the height of the surface irregularities at the wafer interfaces as well as on process temperatures.

Many different light features were observed in our study; most contained features with two morphologies: diamond/rhomboidal-geometry (with edges parallel to <100> directions) and dendrite-geometry (with dendrite arms in the <110> directions). As shown in Fig. 4, dendrite caps with <100> orientation were bounded by {111} planes and the (001) wafer plane, while the diamond features were bounded by {110} planes and the (001) wafer plane, again verified using transmission electron microscopy (TEM).

171

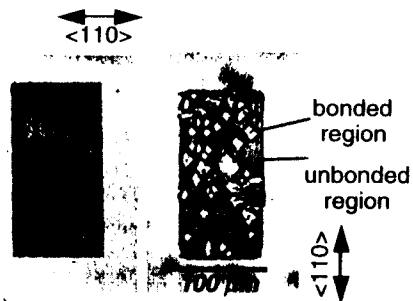

(a) (b)  
Fig. 2. IR transmission optical microscope images of interfacial voids (originally 700 Å deep) on GaAs (100) wafers after bonding at temperatures of (a) 870 and (b) 910°C for 2hr.

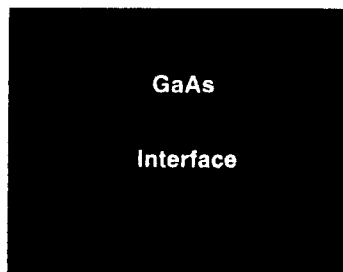

Fig. 3. Cross-sectional high resolution TEM of (100)-oriented GaAs bonded area at 850 °C, showing intimate contact between the two GaAs plates with no intervening oxide layer.

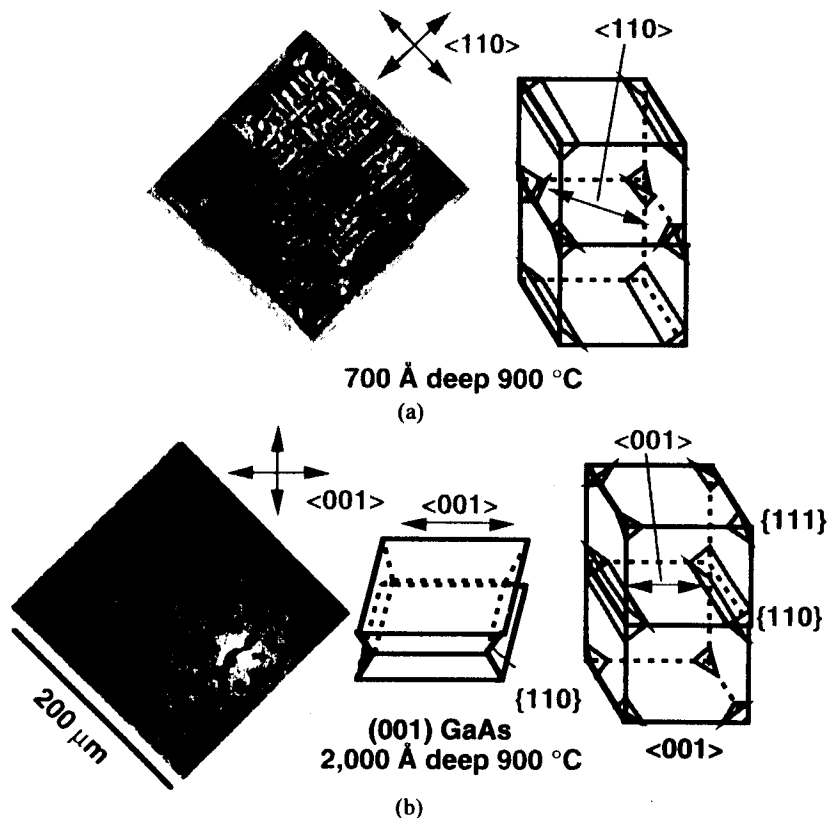

Fig. 4. Illustration of the (a) cap of dendrite light regions and (b) edges of the diamond.

In Fig. 5, the size of the bonded areas in 2,000 Å deep voids is shown to increase with time, as expected from the kinetic nature of the process. Diamond-shaped features were observed after annealing at 950°C for  $\geq 0.5$  hr. Regardless of the size of the features, their shape always remained diamond-like.

On the other hand, in 700 Å deep shallow voids, both diamond-shaped and dendrite-shaped features were observed after annealing at 900°C for 3 hr, as shown in Fig. 6. With increasing time, the stability of the diamond edges (bounded by  $\{110\}$  planes and the (001) wafer plane) broke down, and dendritic arms grew at the corners of the diamonds in the  $\langle 110 \rangle$  directions. The average growth rate of the arms in length was around 7 - 8  $\mu\text{m/hr.}$ , which is much higher than that of the arms in width (0.4 - 0.6  $\mu\text{m/hr.}$ ).

It is important to note that the observed "shape" or "growth habit" of the bonded areas, diamond or dendrite, can result from both surface energy anisotropy and growth rate anisotropy, the latter occurring when a particular crystal face affords easy atomic attachment and grows rapidly. Growth rate anisotropies can result in shapes which exaggerate actual surface energy anisotropies[4].

From the Gibbs-Thomson relationship, the bulk driving force of a curved crystal is given by

$$\Delta G_{\infty} \approx k \frac{\gamma}{R} \approx 2k' \frac{\gamma}{h}$$

where  $\gamma$  is the free energy of the flat surface,  $R$  ( $<0$ ) is the radius of curvature,  $h$  is the depth of the void, and  $k$  and  $k'$  are the geometry constants dependent on the shape and the surface planes (for example,  $\{110\}$  or  $\{111\}$ ) of bonded edge planes).

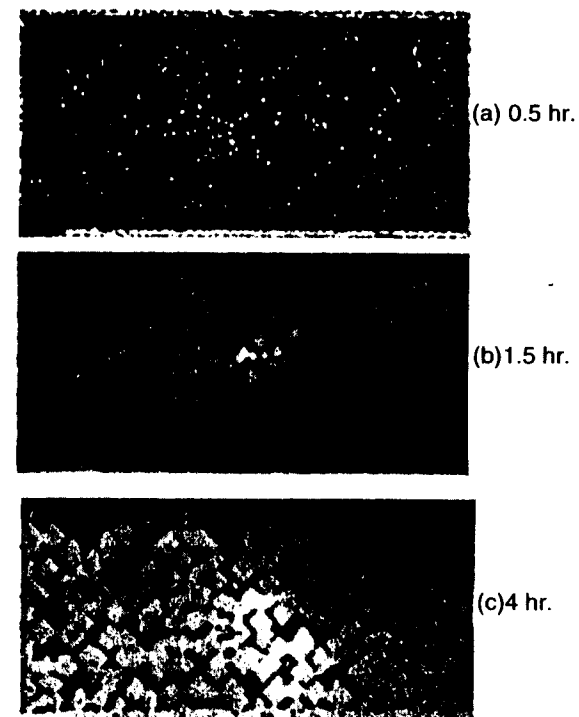

Fig. 5. IR transmission optical micrograph of artificial voids (originally 2,000 Å depth) in GaAs (100) wafers bonded at 950°C for: (a) 0.5 hr, (b) 1.5 hr, (c) 4 hr.

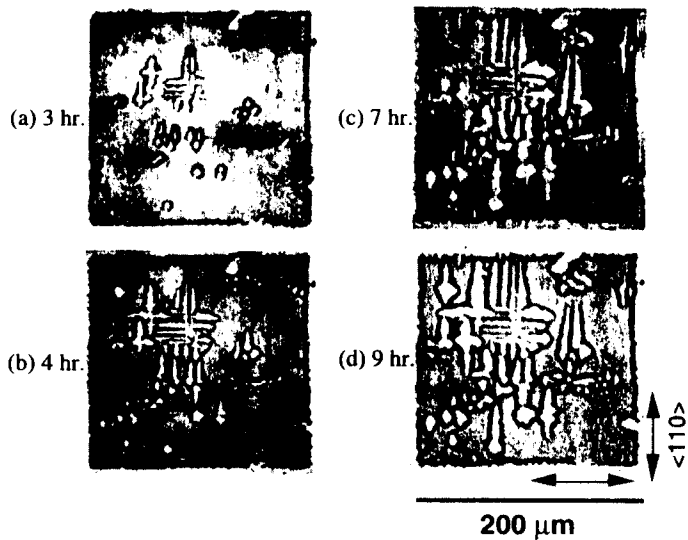

Fig. 6. IR transmission optical micrograph of artificial voids (originally 700 Å depth) in GaAs (001) wafers bonded at 900°C for: (a) 3 hr, (b) 4 hr, (c) 7 hr, and (d) 9 hr.

With a void depth  $h \geq 2,000 \text{ \AA}$ , the driving force is small. According to the surface energy anisotropy, GaAs tends to grow into a low surface energy form. Regardless of the bonding temperatures (850-950 °C) and time, most the bonded areas were diamond-shaped (bounded by very flat {110} planes); therefore, we believe that the surface energies of {110} faces were lower than that of others[5]. On the other hand, when the void depth  $h \leq 700 \text{ \AA}$ , the driving force of the fast grow {111} plane was large enough to break the constraint of the {110} planes, allowing dendrites to grow quickly in the <110> direction.

The interfacial, bulk and surface defect studies described above showed clearly that higher bonding temperatures and longer bonding times lead to an increase in the bonded fraction (i.e., a decrease in interfacial defects), but they also led to an increase in the density of surface and bulk defects. For this reason, a processing temperature of 850 °C was selected as the best temperature for the bonding of the multi-layer stacks necessary for practical nonlinear optical devices.

A 52 layer (100)-oriented stack, of 630 μm thick wafers, was bonded at 850 °C, for 0.5 hr (a somewhat shorter interval than used in the 2 layer studies). The average optical losses per layer were 0.9% at 5.3 μm, and 0.5% at 10.6 μm. Following these experiments, a stack of 39 (110)-oriented wafers, each 500 μm thick, was bonded under the same conditions. The average optical losses per layer were even lower, 0.1 - 0.3% at both 5.3 μm and 10.6 μm, as shown in Fig. 7. The reduced optical losses in the 39 layer stack may have come from the reduction of wafer thickness (shorter absorption pathlength - 630 μm compared with 500 μm), and/or the different properties (mechanical, physical, and chemical) of the different wafer surface orientations, (100) versus (110).

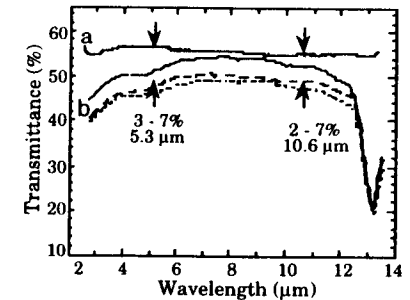

Fig. 7. Observed transmittance of (a) an unprocessed single GaAs wafer, and (b) a 39 layer stack of (110) bonded GaAs wafers at 3 different positions.

## CONCLUSIONS

The optical losses achieved in these studies are considered low enough for practical devices, and we believe continued experiments with custom-fabricated GaAs wafers prepared to the thickness required for specific optical interactions are warranted. Such studies are currently under way.

## ACKNOWLEDGMENTS

This project was funded by DARPA through the Center for Nonlinear Optical Materials at Stanford University, and by the Army Research Office. It has benefited from facilities and equipment made available to Stanford University by the NSF-MRSEC Program through the Center for Materials Research at Stanford University.

The authors would like to thank W. Tiller and D. Vanderwater for valuable discussions.

## REFERENCES

1. L. A. Gordon, G. L. Woods, R. C. Eckardt, R. K. Route, R. S. Feigelson, M. M. Fejer, R. Byer, *Electronics Letters* (1993) **29**, no. 22, pp. 1942-4.
2. J. Rodel, A. M. Glaeser, *Journal of the American Ceramic Society* **73**, pp. 592-601 (1990)
3. S. K. Ghandhi, *VLSI Fabrication Principles - Silicon and Gallium Arsenide, 2nd ed.* p.197, Wiley, New York (1994).
4. Y. Chiang, D. Birnie III, and W. D. Kingery, *Physical Ceramics - Principle for Ceramic Science and Engineering*, p.354, J. Wiley, New York (1997).
5. D. Vanderwater personal communications, 1997.