

Building a Culture of Access

Sean Keegan

Associate Director, Assistive Technology

Office of Accessible Education - Stanford University

How does one begin building an environment based on “Access”?

Location

Slope

Width

Surface

Obstructions

Diagonal Style Ramps







Technology standards and guidelines can be a starting point to improving the accessibility and usability of content/devices

- **Web Content Accessibility Guidelines (WCAG) 2.0**
- **Technology standards of Section 508 of the Rehabilitation Act of 1973**

E & IT Defined

Includes information technology and any equipment or interconnected system or subsystem of equipment, that is used in the creation, conversion, or duplication of data or information. The term electronic and information technology includes, but is not limited to, telecommunications products (such as telephones), information kiosks and transaction machines, World Wide Web sites, multimedia, and office equipment such as copiers and fax machines. The term does not include any equipment that contains embedded information technology that is used as an integral part of the product, but the principal function of which is not the acquisition, storage, manipulation, management, movement, control, display, switching, interchange, transmission, or reception of data or information.

(<http://www.access-board.gov/sec508/guide/scope.htm>)

What that really meant...

- Software and operating systems
- Web-based information and applications
- Telecommunications products
- Video and multimedia products
- Self contained, closed products
- Desktop & portable computers

Criteria	Supporting Features	Remarks and Explanations
<p>(a) When software is designed to run on a system that has a keyboard, product functions shall be executable from a keyboard where the function itself or the result of performing a function can be discerned textually.</p>	<p>Supports with exceptions through equivalent facilitation: Keyboard equivalents for all actions are provided.</p>	<p>Firefox supports all standard keyboard operation of the user interface. Java and in-page plugins for content such as Flash cannot be used with the keyboard so they must not be installed for keyboard-only users. The tab order skips over them completely, so form controls within them cannot be used without a mouse.</p>

E & IT Pop Quiz

- Web Pages?
- Microsoft Windows/OS X/Linux?
- FAX machines and copiers?
- Heating/Ventilation systems?
- Coffee machines?

Automated Teller Machine

- Orientation for the ATM card
- Time limit for interaction
- Keypad for entering numbers
- On-screen menu requiring response

Self-contained, closed products (§1194.25)

- Self contained products shall be usable by people with disabilities without requiring an end-user to attach assistive technology to the product.
- When a timed response is required, the user shall be alerted and given sufficient time to indicate more time is required.
- Controls and keys shall be tactilely discernible without activating the controls or keys.
- Controls and keys shall be operable with one hand and shall not require tight grasping, pinching, or twisting of the wrist.
- When products provide auditory output, the audio signal shall be provided at a standard signal level through an industry standard connector that will allow for private listening.



Self-contained, closed products (§1194.25)

- Self contained products shall be usable by people with disabilities without requiring an end-user to attach assistive technology to the product.
- Controls and keys shall be tactilely discernible without activating the controls or keys.
- The status of all locking or toggle controls or keys shall be visually discernible, and discernible either through touch or sound.
- Controls and keys shall be operable with one hand and shall not require tight grasping, pinching, or twisting of the wrist.

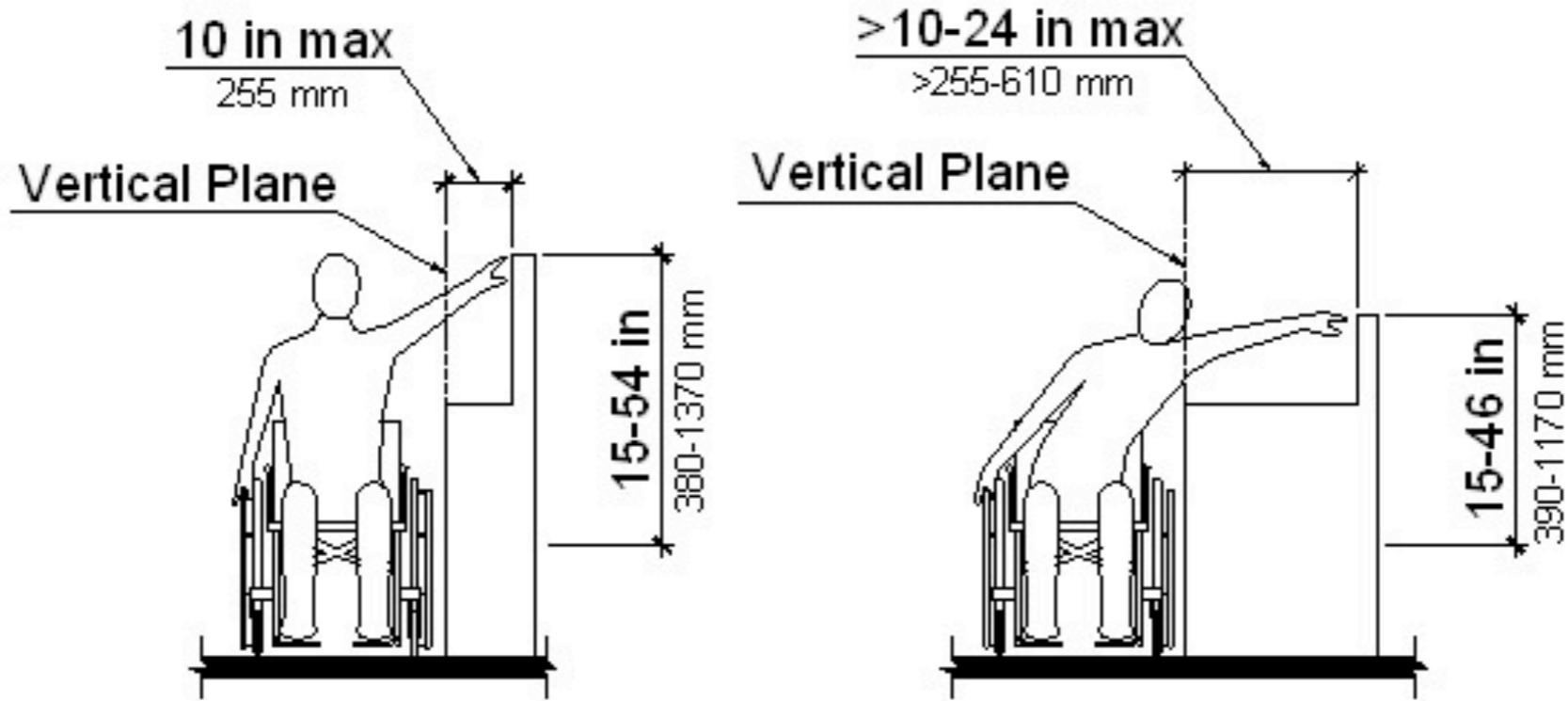

Height of Operable Control Relative to the Vertical Plane

Figure 2



Web-based Information and Applications (§1194.22)



- A text equivalent for every non-text element shall be provided
- Documents shall be organized so they are readable without requiring an associated style sheet.
- A text-only page, with equivalent information or functionality, shall be provided to make a web site comply with the provisions of these standards, when compliance cannot be accomplished in any other way. The content of the text-only page shall be updated whenever the primary page changes.
- A method shall be provided that permits users to skip repetitive navigation links.

Build

Teach

Student View

 **Course Tools**

 Course Content 

 Announcements

 Assessments

 Assignments

Your location: **Announcements**

Announcements

 **Create Announcement**

Order   Title

Emerging areas...

Mobile Hardware/Software combinations

Touchscreen solutions



Gestural/Spatial systems

Resources

- US Section 508 Standards
<http://www.access-board.gov/508.htm>
- WCAG 2.0
<http://www.w3.org/TR/WCAG20/>
- VPAT Sample
<http://www.itic.org/index.php>
(Resources > VPAT)

Thank you

Sean Keegan

Office of Accessible Education - Stanford University

<http://www.stanford.edu/group/DRC/>